



CALL 800-480-6613

SALES
REPAIR

SERVICE
INSTALLATION

INTEGRATION
WARRANTY



FBH ARCHITECTURAL SECURITY
Commercial Doors and Hardware



AL Series

Cylindrical locks





Put your trust in the name you know

Contents

4-5	Mechanical lock guide
6	AL Series introduction and performance features
7	Exploded view
8	Lever designs
9	Lever finishes and door handing
10-11	Lock functions
12	Cylinder types
13	Standard cylinders
13	Primus XP high security cylinders
14	Full size interchangeable core
14	Small format interchangeable core
15	IC conversion kits
15	IC installation tool
16	Latches
17	Strikes
17	Rabbeted latch and strike kit
18	Specifications and certifications

Pictured here: Saturn lever shown in 626 satin chrome

Cover photo: Neptune lever shown in 626 satin chrome finish

For more than 90 years, Schlage has been creating the strongest and most technologically advanced security products for schools, hospitals, hotels, commercial and institutional buildings, multi-family properties and homes. From durable mechanical locks to comprehensive electronic access control solutions and biometrics, Schlage provides protection at critical moments – when property and personal security are at stake. With a wide range of products, styles and finishes, Schlage has products for the most demanding project specifications. In public buildings, in the workplace, and in homes, at the end of the day Schlage stands for one thing: strong.

Be sure to ask your SSC representative to tell you about **Custom Solutions** by Allegion. To learn more visit allegion.com/us.



Quiet Solutions



Custom Décor



High Security and Safety



Environmental Solutions



Flexible Configurations

Real security is knowing exactly what you want and getting it

When you know exactly what you want, you don't want to waste time finding out whether it meets your project specifications. That's why we offer the world's largest team of hardware specification writers to help you and your clients turn your vision into reality. And when it comes to products, our commercial suiting options, wide variety of lever designs and rich selection of finishes give you the tools you need to make your projects perfect. You know what you want. With Schlage, you can be sure you'll get it.

Safety, security and confidence

When you choose a Schlage lock, you can be sure you've done the job right, the first time. After all, our products are among the most durable and dependable on the market today. Our locks are easy to install, and simple to repair and maintain. That means fewer callbacks for you, and total safety and security for your customers.





Tubular interconnected locks



Tubular locks

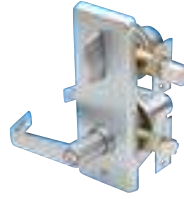

Tubular interconnected locks





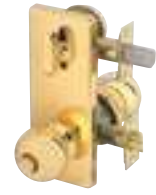

Cylindrical locks



Cylindrical interconnected locks

CS200 Series	S Series	S200 Series	A Series	H Series
Grade 2	Grade 2		Grade 2	
Security level:				
ANSI/BHMA certified A156.2-2013 Exceeds 400,000 ANSI cycles Medium traffic	ANSI/BHMA certified A156.2-2011 Exceeds 400,000 ANSI cycles Light traffic	- - Exceeds 400,000 ANSI cycles Medium traffic	ANSI/BHMA certified A156.2-2011 Exceeds 400,000 ANSI cycles Medium traffic	- - Exceeds 400,000 ANSI cycles Medium traffic
Typical applications:				
Exterior Interior New construction Retrofit	- Interior - Retrofit	Exterior Interior New construction Retrofit	Exterior Interior New construction Retrofit	Exterior Interior - Retrofit
Functions available:				
1 Function - -	6 Functions - -	5 Functions - -	11 Functions - -	5 Functions - -
Design options:				
7 Finishes 15 Lever styles - 1 Matching rose 2 Interior escutcheons Tactile warning available	7 Finishes 4 Lever styles - 1 Matching rose - Tactile warning available	7 Finishes 4 Lever styles - 1 Matching rose 1 Interior escutcheon -	10 Finishes 1 Lever style 4 Knob styles 1 Matching rose - -	7 Finishes 1 Lever style 2 Knob styles 1 Matching rose 1 Interior escutcheon -
Often used in:				
Commercial Multi-family Office	Commercial Multi-family Office	Commercial Multi-family Office	Commercial Govt/military Healthcare Hospitality Office Retail	Commercial Govt/military Multi-family

Not all functions and finishes available with all products. Please consult your SSC representative for details.

					
Cylindrical locks	Deadbolts	Cylindrical locks	Cylindrical locks	Mortise locks	
AL Series	B Series	D Series	ND Series	L Series	
Grade 2	Grade 2	Grade 1	Grade 1	Grade 1	
Security level:					
ANSI/BHMA certified A156.2-2011 Exceeds 400,000 ANSI cycles Medium traffic	ANSI/BHMA certified A156.5-2010 Exceeds 150,000/250,000 ANSI cycles High traffic, heavy-duty	ANSI/BHMA certified A156.2-2011 Exceeds 1,000,000 ANSI cycles High traffic	ANSI/BHMA certified A156.2-2011 Exceeds 1,000,000 ANSI cycles Heavy-duty traffic	ANSI/BHMA certified A156.13-2012 Exceeds 1,000,000 ANSI cycles Heavy-duty traffic	
Typical applications:					
Exterior Interior New construction Retrofit	Exterior - New construction Retrofit	Exterior Interior - Retrofit	Exterior Interior New construction Retrofit	Exterior Interior New construction Retrofit	
Functions available:					
10 Functions - -	7 Functions - -	6 Functions - -	14 Functions 2 Electrified -	29 Functions 6 Electrified Vandlgard® available	49 Functions 4 Electrified Vandlgard® available
Design options:					
10 Finishes 4 Lever styles - 1 Matching rose - Tactile warning available	10 Finishes - - - - Indicator rose	10 Finishes - 3 Knob styles 1 Matching rose - -	9 Finishes 5 Lever styles - 2 Matching roses - Tactile warning available	13 Finishes 26 Lever style 3 Knob styles 4 Matching roses 2 Escutcheons Tactile warning available Antiligature available	
Often used in:					
Commercial Healthcare Hospitality Office Retail	Commercial/institutional Govt/military Heavy-duty residential Hospitality Office Retail	Institutional Govt/military Hospitality Retail	Institutional Education Healthcare Office Retail	Commercial/institutional Govt/military Education Healthcare Office Retail	

This chart shows the most common uses/applications. These products are often used in other applications in addition to those listed.

Rev. 11/13

AL Series

Dependable performance for high traffic commercial applications

At Schlage, we know that every product you specify has to stand up to constant use, while meeting your needs for security at every level. Our AL Series locks are designed to deliver ADA compliant accessibility and constant, reliable performance. The AL Series is best for buildings with medium to high traffic flow, such as interior office doors, banks, retail spaces and hotel guest areas. With a Grade 2 ANSI rating, and styles and finishes to suit your building's design, the AL Series fits right where you need it.

Pictured here: Jupiter lever shown in 626 satin chrome



We don't compromise on security

The safety and security of your clients' buildings is something we take very seriously. That's why every Schlage lock and deadbolt undergoes intensive testing to determine its ANSI grade level:

- Cycle tests
- Resistance tests
- Door impact tests
- Warped door tests
- Bolt strength tests

We pay attention to these details so you can focus on creating a functional and aesthetically pleasing environment for your clients. In fact, every one of our AL Series locks meets ANSI Grade 2 standards for safety.

The lever that looks as good as it performs

- Cold-rolled steel, machined and threaded hubs, and locking nuts prevent the loosening of the lockset by securely bolting the chassis to the door
- Large diameter of mounting plate and rose covers new ANSI hollow metal door cutout
- Patented door range adjuster allows quick and easy adjustment for doors ranging from 1³/₈" to 1⁷/₈" (35 mm to 48 mm) thick

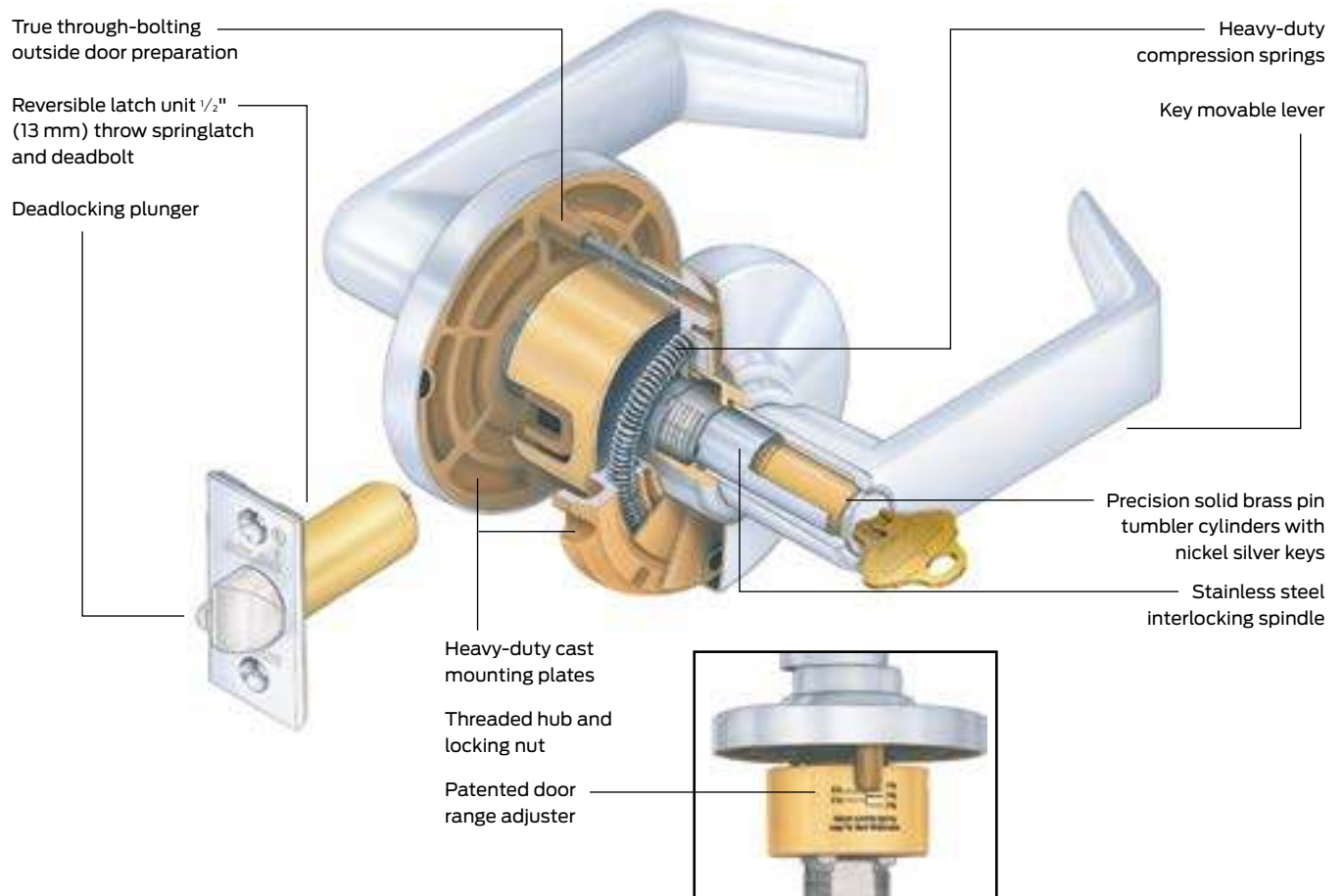

AL Series lever designs

Jupiter (JUP)



Symbol: JUP
Material: Pressure cast zinc lever; wrought brass or bronze rose
Suites: S Series **JUPITER**, ND Series **ATHENS** and L Series **07** designs



Neptune (NEP)



Symbol: NEP
Material: Pressure cast zinc lever; wrought brass or bronze rose
Suites: S Series **NEPTUNE**, ND Series **SPARTA** and L Series **17** designs



Omega (OME)



Symbol: OME
Material: Pressure cast zinc lever; wrought brass or bronze rose
Suites: ND Series **OMEGA** and L Series **OMEGA** designs



Saturn (SAT)



Symbol: SAT
Material: Pressure cast zinc lever; wrought brass or bronze rose
Suites: S Series **SATURN**, H Series **LEVON**, ND Series **RHODES** and L Series **06** designs
Options: Tactile warning



Tactile warning

Milled

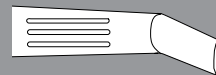

Order as follows:
BSA for Saturn

Only available on outside lever, unless otherwise specified

All designs shown in 626 satin chrome

- = Standard cylinder.
- = FSIC - Full size interchangeable core option.
- = SFIC - Small format interchangeable core option.
- = Complies with ADA accessibility guidelines.
- = Antimicrobial coating available on 626 finish only.
- = Meets California code for 1/2" or less return to the door.
- = Extended factory lead time.

Lever finishes

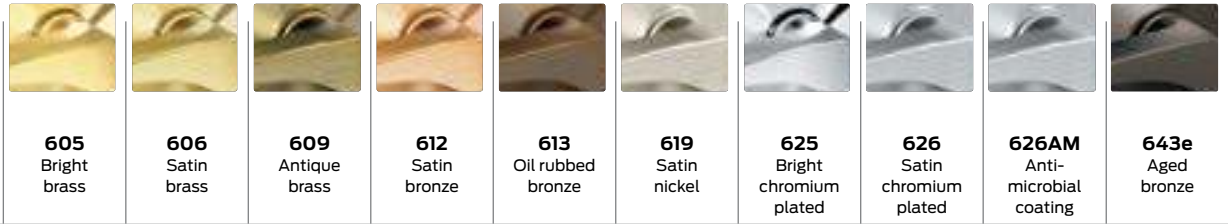

AL Series locks										
Jupiter	•	•		•	•	•	•	•	•	•
Neptune	•	•	•	•	•	•	•	•	•	•
Omega	•	•	•	•	•	•	•	•	•	•
Saturn	•	•	•	•	•	•	•	•	•	•

e = an equivalent finish to the BHMA standard.

Door handing

All Schlage locks are reversible. Hand information is necessary to ensure proper cylinder orientation in keyed functions, and finish of latchbolt and strike for locks that are to be installed on reverse bevel doors. Follow the diagram to correctly determine the hand of the door.

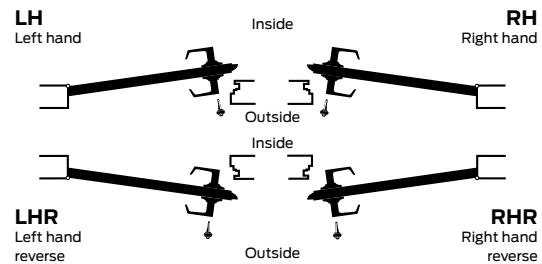

ADA-compliant products

In compliance with the American National Standards Institute (ANSI A117.1) and the Americans with Disabilities Act (ADA), Schlage Lock Company offers a wide selection of locks designed for the needs of the physically challenged. This act is designed to provide protection for people with disabilities.

The intent of ADA is that owners of certain types of buildings must remove barriers and provide people with disabilities with access equal to, or similar to, that available to the general public.

Product information and specifications contained in this catalog are subject to change without notice. Please consult the factory.

Lock functions

ANSI A156.2 Series 4000 Grade 2

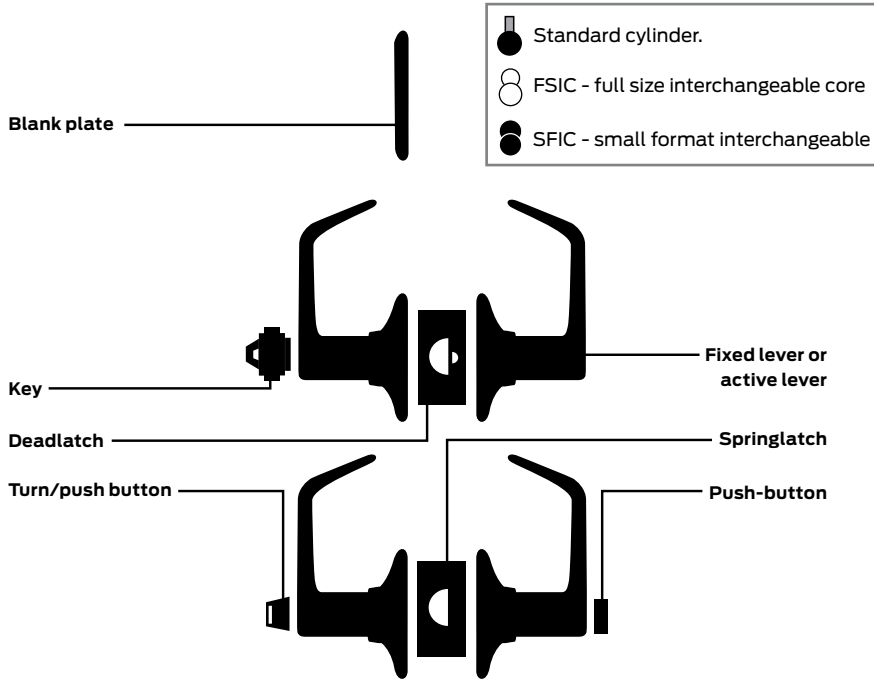

Non-keyed functions

Schlage ANSI
AL10S **F75**

Passage latch

- Both levers always unlocked.
- Inside lever always free for immediate egress.

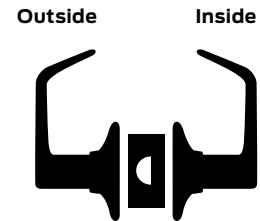

Schlage ANSI
AL25D -

Exit lock

- Blank plate outside.
- Inside lever always unlocked.
- Inside lever always free for immediate egress.
- Specify door thickness.

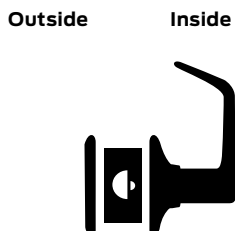

Schlage ANSI
AL40S **F76**

Bath/bedroom privacy lock

- Push-button locking.
- Can be unlocked from outside with small screwdriver.
- Turn inside lever or close door to release button.
- Inside lever always free for immediate egress.

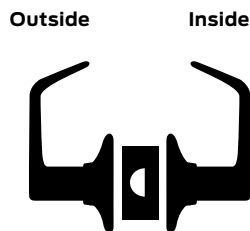

Schlage ANSI
AL44S -

Hospital privacy lock

- Push-button locking.
- Unlock from outside by turning emergency turn-button.
- Turn inside lever or close door to release button.
- Inside lever always free for immediate egress.

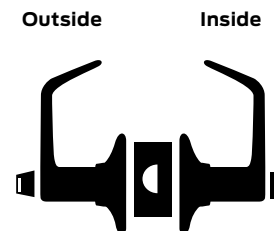

Lock functions

ANSI A156.2 Series 4000 Grade 2

Keyed functions

Schlage ANSI

AL170 -

Single dummy trim

- Single dummy trim for one side of door.
- Used for door pull or as matching inactive trim.

Outside or Inside



Schlage ANSI

AL50PD **F82**

Entrance/office lock

- Push-button locking.
- Push-button locks outside lever until it is unlocked with a key or by rotating the inside lever.
- Inside lever always free for immediate egress.

Outside Inside

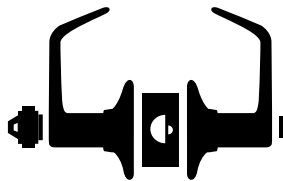

Schlage ANSI

AL53PD **F109**

Entrance lock

- Turn/push-button locking: pushing and turning button locks outside lever, requiring use of a key until the button is manually unlocked.
- Push-button locking: push-button locks the outside lever until it is unlocked by key or by turning the inside lever.
- Inside lever always free for immediate egress.

Outside Inside

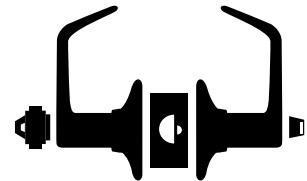

Schlage ANSI

AL70PD **F84**

Classroom lock

- Outside lever is locked and unlocked by key.
- Inside lever is always unlocked.
- Inside lever always free for immediate egress.

Outside Inside

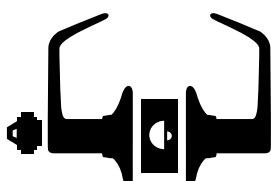

Schlage ANSI

AL80PD **F86**

Storeroom lock

- Outside lever is fixed.
- Entrance by key only.
- Inside lever is always unlocked.
- Inside lever always free for immediate egress.

Outside Inside

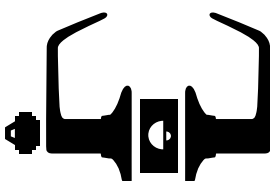

Schlage ANSI

AL85PD **F93**

Faculty restroom lock (with indicator cylinder)

- Outside lever is fixed.
- Entrance by key only.
- Push button on inside lever activates visual occupancy indicator, allowing only the emergency masterkey to operate.
- Rotate inside lever or close door to release visual occupancy indicator.
- Rotation of inside spanner button provides lockout feature by keeping indicator thrown.
- Inside lever always free for immediate egress.

Outside Inside

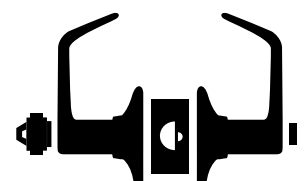





Cylinders and key systems

Protect new key systems with Everest 29

Schlage can help you design a system that can grow and change along with your needs, allowing you the flexibility to upgrade your security without the need to replace all your cylinders.

Upgrade existing classic key systems with Primus XP

Schlage offers key system solutions that are ideal for upgrading an existing key system to control key management. Our patent-protected cylinders help prevent unauthorized duplication and can be integrated into virtually any existing system.

What it operates		What it is	
<ul style="list-style-type: none"> Everest 29 Primus[®] XP cylinders Everest 29 restricted cylinders Everest 29 open cylinders 	<ul style="list-style-type: none"> UL 437 version UL 437 versions provide drill and pick resistance and withstand physical attack High security cylinders have a second set of pins for added security Patented key control sold with various levels of geographic exclusivity Keys operate high security, as well as restricted security or standard security cylinders Available only in conventional 	<ul style="list-style-type: none"> Everest 29 Primus XP cylinders Everest 29 restricted cylinders Everest 29 open cylinders 	<ul style="list-style-type: none"> Controlled access Patented key control sold with various levels of geographic exclusivity High security cylinders have a second set of pins for added security and pick resistance Keys operate high security, as well as restricted security or standard security cylinders Available only in conventional and FSIC  <p>EVEREST 29[™] PRIMUS XP High security</p>
<ul style="list-style-type: none"> Everest 29 restricted cylinders 	<ul style="list-style-type: none"> Key distribution is restricted duplication must be authorized End user's ID numbers are stamped on all keys, enabling Schlage to identify the source of any unauthorized keys Patent-protected keys are drop-shipped from the factory directly to an end-user specified location to guarantee exclusivity Available in conventional, SFIC and FSIC 	<ul style="list-style-type: none"> Everest 29 open cylinders 	<ul style="list-style-type: none"> Controlled access Patented key control sold with various levels of geographic exclusivity High security cylinders have a second set of pins for added security and pick resistance Keys operate high security, as well as restricted security or standard security cylinders Available only in conventional  <p>EVEREST 29[™] Restricted security</p>
<ul style="list-style-type: none"> Everest 29 open cylinders 	<ul style="list-style-type: none"> Patented key blanks can be stored by commercial locksmiths and security dealers Keys can be duplicated without any paperwork or signature verification Sold only through commercial outlets Available in conventional and FSIC 	<ul style="list-style-type: none"> Primus XP cylinders Classic cylinders 	<ul style="list-style-type: none"> Controlled access Patented key control sold with various levels of geographic exclusivity High security cylinders have a second set of pins for added security and pick resistance Keys operate high security, as well as restricted security or standard security cylinders Available only in conventional  <p>PRIMUS XP High security</p>
		<ul style="list-style-type: none"> Classic cylinders 	<ul style="list-style-type: none"> Basic security Keys can be duplicated at most retail and commercial points of sale with no restrictions Recommended only for residential applications or existing commercial systems that cannot rekey Can be upgraded to Primus XP without rekeying the entire facility Available in conventional and FSIC  <p>CLASSIC Basic security</p>

Standard cylinders

Standard cylinders are available in Classic keyways or in patented Everest 29 keyways.

Specify keyway to differentiate between Everest 29 and Classic.

Example: C (Classic) vs. S123 (Everest 29).

Standard cylinders - options

- Conventional 6-pin cylinder (standard)
- Primus high security cylinder
- Primus UL437 listed high security cylinder
- Conventional 6-pin AL85 function with occupancy indicator

Available in 606 and 626 finish only.
Everest 29 S123 keyway standard.



Example of lock with
cylinder for most functions



AL85 cylinder with
occupancy indicator

Primus XP access control and high security cylinders

Primus XP access control and high security cylinders are available to add patented key control and varying degrees of geographical exclusivity to most Schlage 6-pin key systems, whether Everest 29 or Classic keyways.

In addition to a conventional pin tumbler mechanism, Primus cylinders incorporate a patented finger pin and sidebar design, providing a “dual-locking” cylinder that is virtually pick-proof. Resistance to drilling and other physical attack is optional by specifying 20-500 Series UL437 Listed cylinders.

Classic Primus XP cylinders are recommended for upgrading existing Classic key systems. Due to its extended patent life, the newly designed Everest 29 Primus XP is recommended for new key systems and for upgrading existing Everest key systems. Specify keyway to differentiate between Everest 29 and Classic. Example: C or CP (Classic) vs. S123 (Everest 29).

Visit allegion.com/us for more information.

Full size interchangeable core

Schlage interchangeable core (IC) locksets allow immediate rekeying at the door simply by using the special control key to replace the core in seconds. IC locksets are available in Saturn design only.

Full size core



FSIC can be integrated into any 5 or 6-pin Schlage key system.



Full size interchangeable cores - options (for JD suffix locksets)

- Conventional core
- Primus XP high security core

Available in 606 and 626 finish only.
Everest 29 S123 keyway standard.

Small format interchangeable core

The SFIC version is designed for Schlage Everest 29 R family restricted keyway cores and is also completely compatible with Best®, Falcon and other competitive small format cores.

Small format core



Small format interchangeable cores - options (For BD suffix locksets)

- 7-pin uncombined Everest 29 R family restricted keyways
- 7-pin combined Everest 29 R family restricted keyways
- 6-pin uncombined Falcon / Best keyways
- 7-pin uncombined Falcon / Best keyways
- Disposable plastic construction core

Available in 606 and 626 finish only. Specify keyway for existing systems.

80-033 and 80-043 cores are available in A, D, E, F, G, H, J, K, L, and M keyways.

80-036 and 80-037 restricted keyway cores require a letter of authorization from the end user. Schlage assigns the keyway when establishing new Everest 29 restricted key systems.

IC conversion kits

It is easy to convert standard AL Series locksets to accept Schlage full size interchangeable cores by changing the lever and adding the parts shown.

Conversion to SFIC requires different components, as well as dismantling the lockset to replace internal parts. No kits are available for this purpose.

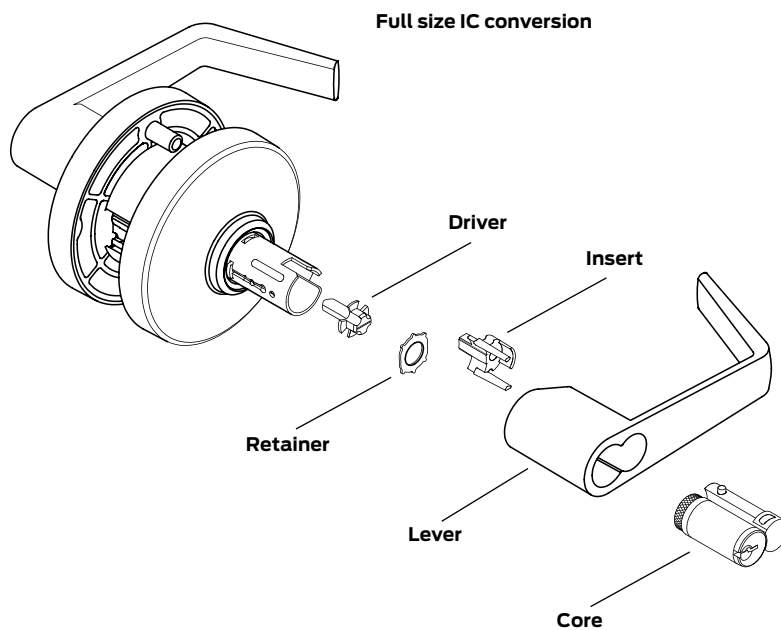

Interchangeable core components - options

- Conversion kit: driver, retainer, lever, core *
- Conversion kit: driver, retainer, lever
- Driver, retainer
- Lever only (Saturn)*
- IC installation tool

*Specify finish.

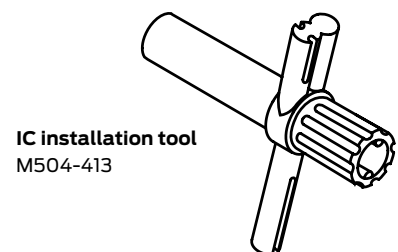

Latches

AL Series latches are adjustable for flat or beveled edge doors. Latches and strikes are furnished in brass, bronze or chrome finishes compatible with lock trim. When ordering separately, specify quantity, part number, and finish. Standard latches shown in bold type.

Latches

Backset	Faceplate description	Hsg dia	Deadlatch 1/2" (13 mm) throw	Springlatch 1/2" (13 mm) throw
2 3/8" (60 mm)	1" x 2 1/4" (25 mm x 57 mm) square corner	7/8" (22 mm)	11-085	11-068
	1" x 2 1/4" (25 mm x 57 mm) 1/4" (6 mm) radius round corner	7/8" (22 mm)	11-088	11-069
	1" (25 mm) circular drive-in (non-UL) 605 and 626 finishes only	1" (25 mm)	11-104	11-110
2 3/4" (70 mm)	1" x 2 1/4" (25 mm x 57 mm) square corner	7/8" (22 mm)	11-091	11-111
	1 1/8" x 2 1/4" (29 mm x 57 mm) square corner, standard	1" (25 mm)	11-096	11-116
	1" x 2 1/4" (25 mm x 57 mm) 1/4" (6 mm) radius round corner 605 and 626 finishes only	7/8" (22 mm)	11-092	11-112
	1" (25 mm) circular drive-in (non-UL)	1" (25 mm)	11-105	11-113
3 3/4" (95 mm)	1 1/8" x 2 1/4" (29 mm x 57 mm) square corner	1" (25 mm)	11-103	11-118
5" (127 mm)	Backset extension link*	7/8" (22 mm)	41-005*	

*Backset extension link 41-005 must be used with 2 3/8" backset latches.

Square corner latches

Springlatch

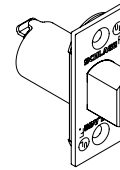

Deadlatch

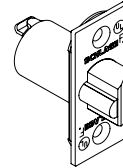

Round corner latches

Springlatch

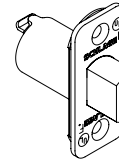

Deadlatch

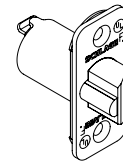

Drive-in latches

Springlatch

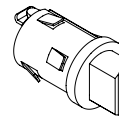

Deadlatch

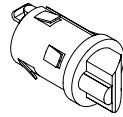

Long backsets

Backsets 5" require extension links. AL Series locks with long backsets are normally furnished with 1" faceplates and 7/8" housings. Links installed in 1" latch holes require one G506-815 sleeve (order separately) to join latch and link.

5" extension link

41-005

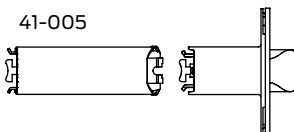

(add to 2 3/8" backset latch)

Sleeve

G506-815
(order separately)



Latch front adapter

A501-878

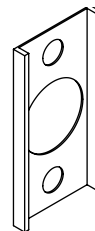

Used to convert 1" wide square front faceplates for 1 1/8" wide door preparations. Furnished in black plastic. Order in units of 100 each.

Door reinforcement

Reinforcing unit is required to reinforce and help prevent the collapse of hollow metal doors when locksets are tightly mounted. This kit should be used with long backsets for AL Series lock installations in hollow metal doors to prevent lateral movement of the latchbolt. Specify door thickness, 1³/₈" (35 mm) or 1³/₄" (44 mm), when ordering reinforcement kits.

Reinforcement kit 37-001

Kit includes:

Reinforcement

A501-566 for 1³/₄" doors or
A501-565 for 1³/₈" doors

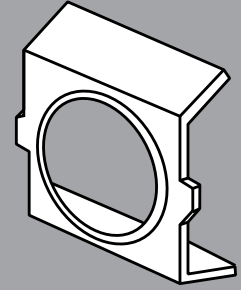

Strikes

All Schlage strikes are furnished complete with screws. The 10-025 standard AL Series strike has a 1³/₁₆" (30 mm) lip. Standard strikes shown in bold type.

ANSI strike – standard

10-025
1¹/₄" x 4⁷/₈" x 3³/₃₂"
(32 mm x 124 mm x 2 mm)

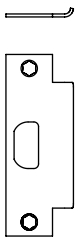

T-Strike

10-001
1¹/₈" x 2³/₄" x 3³/₃₂"
(29 mm x 70 mm x 2 mm)

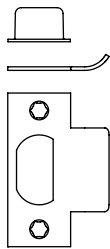

Strikes

Number	Lip length	Description
10-001	1", 1 ¹ / ₈ " (std), 1 ¹ / ₄ ", 1 ¹ / ₂ ", 1 ³ / ₄ ", 2" (25 mm, 29 mm, 32 mm, 38 mm, 44 mm, 51 mm)	1 ¹ / ₈ " x 2 ³ / ₄ " (29 mm x 70 mm) square corner, box, standard
10-004	1 ¹ / ₈ " (29 mm)	1 ¹ / ₈ " x 2 ³ / ₄ " (29 mm x 70 mm) 1 ¹ / ₈ " (3 mm) radius, round corner
10-025	1³/₁₆", 1³/₈" (30 mm, 35 mm)	1¹/₄" x 4⁷/₈" (32 mm x 124 mm) ANSI
10-026	1 ¹ / ₈ " (29 mm)	1 ⁵ / ₈ " x 2 ¹ / ₄ " (41 mm x 57 mm) full lip, square corner
10-027	1 ¹ / ₈ " (29 mm)	1 ⁵ / ₈ " x 2 ¹ / ₄ " (41 mm x 57 mm) full lip, 1 ¹ / ₄ " (6 mm) radius, round corner
10-058	1 ⁷ / ₃₂ " (31 mm)	1 ³ / ₄ " (44 mm) circular, adjustable
K510-066	—	Box for ANSI strike

*Use with 2³/₄" square corner strikes only.

Rabbeted latch and strike kit

Rabbeted latch and strike kit finishes: 606, 626. This kit adapts square corner latches and strikes for 1/2" (13 mm) rabbeted door and frame preparations.

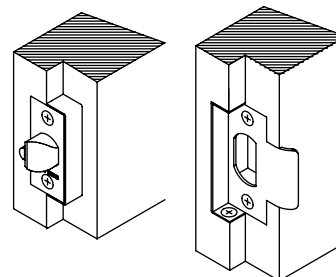

Rabbeted latch and strike kit
39-030

Specifications

Handing:

Non-handed.

Door thickness:

1³/₈" to 1⁷/₈" (35 mm to 48 mm) standard.

2" (51 mm) optional.

Backset:

2³/₄" (70 mm) standard. 2³/₈" (60 mm), 3³/₄" (95 mm)

and 5" (127 mm) optional.

Front:

Steel. 2¹/₄" x 1¹/₈" square corner, beveled, for 2³/₄" backset standard. Optional 1" square corner, 1" radius corner, and non-UL drive-in / round face. For availability with specific backsets, see page 16.

Lock chassis:

Steel, zinc dichromated for corrosion resistance

Latch bolt:

Brass, chrome plated, 1/2" throw, deadlocking on keyed and exterior functions.

Exposed trim:

Wrought brass and bronze. Levers are pressure cast zinc, plated to match finish symbols.

Strike:

ANSI curved lip strike 4⁷/₈" x 1¹/₄" x 1¹/₄" lip to center standard. Optional strikes, lip lengths and ANSI wrought strike box available. See page 17.

Cylinder and keys:

6-pin patented Everest 29 S123 keyway standard with two nickel silver keys per lock.

Keying options:

Interchangeable core and Primus® high security cylinders. Master keying, grand master keying, and construction keying.

Warranty:

Three-year limited.

Certifications

ANSI:

Meets or exceeds A156.2 Series 4000, Grade 2 strength and operational requirements.

Meets A117.1 Accessibility Code.

Federal:

Meets FF-H-106C.

California State Reference Code:

(Formerly Title 19, California State Fire Marshal Standard)

All levers with a return to door of 1/2" (64 mm) or less comply.

UL / cUL:

All locks listed for A label single doors, 4' x 8'.

Letter F and UL symbol on latch front indicate listing.

UL437 Listed locking cylinder optional: specify Primus 20-500 Series cylinder.

ADA compliant:

Schlage Lock Company offers a wide selection of locks designed to meet the Americans With Disabilities Act.

About Allegion

Allegion (NYSE: ALLE) creates peace of mind by pioneering safety and security. As a \$2 billion provider of security solutions for homes and businesses, Allegion employs more than 7,800 people and sells products in more than 120 countries across the world. Allegion comprises 23 global brands, including strategic brands CISA®, Interflex®, LCN®, Schlage® and Von Duprin®.

For more, visit www.allegion.com

aptiQ ■ LCN ■ **SCHLAGE** ■ STEELCRAFT ■ VON DUPRIN